



### Why Scene Lighting?

Scene lighting has long been used in the commercial world for restaurants, conference facilities etc. Gaining its name from the theatre where complex lighting changes are needed for each Scene, it allows users to recall a lighting mood by pressing one button rather than adjusting several rotary knob type dimmers. Push button control also allows two (or more) way control of lighting, hand held remotes and integration with home cinema, home automation or security systems. All Rako dimmers will also offer soft start and voltage controlled maximum output which greatly improves the lamp life of incandescent and halogen lamp types.

### BASIC PRINCIPLES

Each Rako dimmer (or channel in a RAK system) remembers four different level settings for each of the 4 possible lighting Scenes or Moods. When a button is pressed on a Rako wall-panel the message is transmitted via a coded Radio signal to the dimmer/receivers. Each dimmer then fades to the setting assigned for that button.

Scene Button	Dimmer 1 Wall-lights	Dimmer 2 Downlights	Dimmer 3 Pendant	Dimmer 4 Uplight
1	100%	60%	100%	Off
2	70%	20%	50%	100%
3	100%	10%	30%	60%
4	40%	15%	40%	30%
Off	Off	Off	Off	Off

When button two is pressed in the above example the lights in the room will cross fade to a setting with the wall-lights at 70% the downlighters at 20% the pendant at 50% and the uplight at 100%. This might be, for example, the setting that is best for viewing TV. Other scenes could be for reading, general use and relaxing late at night with a glass of wine! Once a scene has been recalled its overall level can be adjusted using the raise/lower buttons. This is a temporary adjustment, the permanent scene levels are set by programming from the wall-panels, or by using the Rako software.

### WHY RF (RADIO) CONTROL ?

Most scene control systems dictate that the lighting circuits be bought back to a central dimmer box or rack and that the control panels are connected to this using data cabling. This is not normal domestic wiring and may well be undesirable for a new installation or even impossible for a retro-fit project. Rako's wireless system is designed so that the dimmer modules can be fitted into a standard domestic wiring scenario and the control panels communicate with the modules using RF signalling, thus eliminating the need for data cabling. A modular wireless system allows for easy expansion at a later stage.

### Ceiling mount dimmers for downlights

For either mains or low voltage spotlights the RDL250C or RDL500C modules can be fitted through a standard 50mm downlight cutout. The existing switch should be removed and the switched live given permanent power. The old switch can now be replaced by a Rako RCP07 panel.

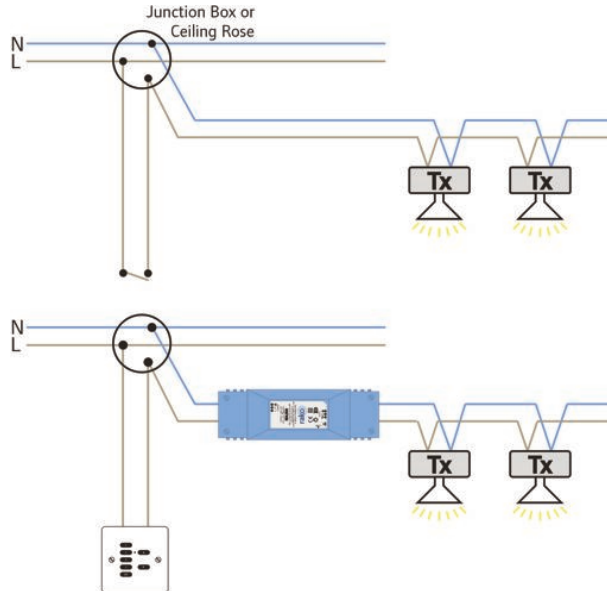

### In-line for free standing lamps

RDL250L or RDL500L modules can be wired in-line with the flex for a free standing lamp. One module could feed a 'ring' of socket outlets but this would dictate dedicated wiring and special 2A or 5A sockets to avoid normal appliances being plugged into a dimmed output.

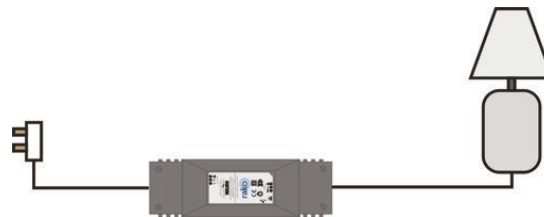

### Wall lights or pendants

The Rako PILL dimmer module can be used for circuits where access to the wiring is particularly difficult. This is often the wall lights or sometimes the central pendant, where the only access is to the switched line behind the switch. The PILL dimmer fits into a (deep) UK back box, and does not need a neutral connection. The PILL is rated for 60-250w and is suitable for mains voltage lighting only. (If there is room for a transformer there is normally room for a Rako RDL series dimmer).

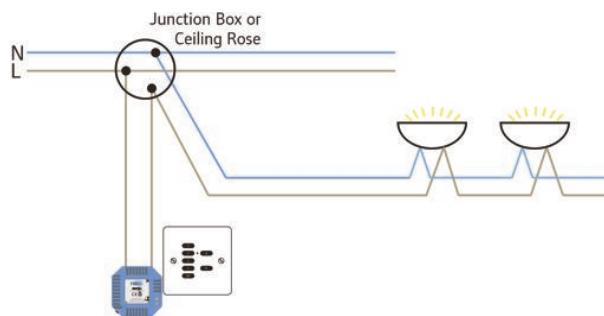

## APPLICATION SHEET

# RAKO CONTROLS

MODULE TYPES (SEE DATA SHEETS FOR MORE DETAIL)

### Larger Circuits

The RDL1200-C can control up to 1200w of mains voltage tungsten or tungsten halogen or 1050w of low voltage. Being a larger unit it will not fit through a down-light cut-out and will need more careful locating.



### Centralised Solutions

Rako's RAK-4 system provides a neater installation option for projects where all the lighting wiring is brought back to a central location (although the RDL module range will function exactly the same). A remote receiver (Rxlink) is required for each 'stack' of up to four RAKs. The RxLink can be located remotely allowing the RAK's to be mounted a considerable distance from the wall panels and other transmitters. The RAK-4 solution requires commissioning using RASOFT programming software and is generally suitable for larger projects. RAK-4s can be used in conjunction with all other Rako modules to form a hybrid system. RAK units are available as 4 channel blocks that can be connected together to form up to 16 channel 'stacks', each RAK being either 4 channels of dimming for incandescent, halogen or low-voltage lighting or 4 channels of fluorescent dimming/switching (RAK-4F).



### Fluorescent Dimming

Rako's fluorescent dimmer modules are designed to dim fluorescent fittings with separate dimmable ballasts. These ballasts require a control pair as well as the mains supply, the control requirements either being 0-10V (Also called 1-10V), DSI (Digital Serial Interface), or DALI (Digital Addressable Lighting Interface). The appropriate Rako modules for these types of ballast are the RDF800-C, RDDSI and RDDALI respectively. These modules are only suitable for use with dimmable ballasts and will not dim the energy saving lamps (which have integral non-dimmable ballasts) although new lamp technologies may improve in this area soon.

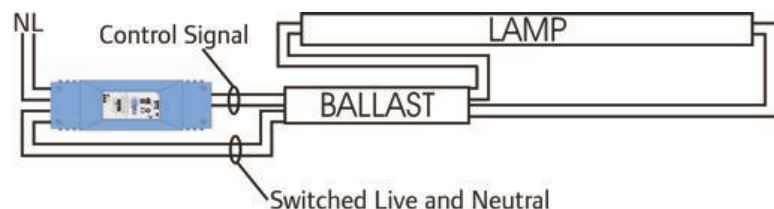

## Switching

For non-dimmable loads such as LEDs (other than DMX controlled LEDs) energy saving lamps, pumps and extract fans Rako provides the RDS800-C. This module switches mains voltage through a relay and so stops any possibility of having, for example, motors set on a dimmed level that may stall them. As the switching device is a relay this is the best module for LED's which as LED fittings often fall under the minimum load requirement for a dimmer, causing unstable operation. The RDS800-C is not designed for use with curtain or blind motors, instead the RACUB unit should be used.

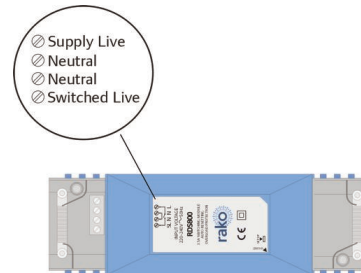

## DMX Control

Some 3 colour LED fittings (and some other light sources such as fibre optic projectors with colour wheels etc) have DMX controlled drivers. DMX is a digital communication protocol originating from theatre control systems. Rako's RADMX unit outputs 8 channels of DMX (although normally only 3 are used, one for each of the three primary colours). The DMX channels being used act as normal dimming channels, so by adjusting the levels of each channel new colour mixes can be achieved for each scene. If the DMX is being used in conjunction with conventional lighting then a new colour can be incorporated into each scene. By default the raise button will start a cycle between the colours set for each of the scenes and the lower button stops the cycle, this can be switched off using RASOFT although master raising and lowering of colours is likely to distort the original colour as it dims. The speed of the cycling can be adjusted by controlling the fade rate of the module.

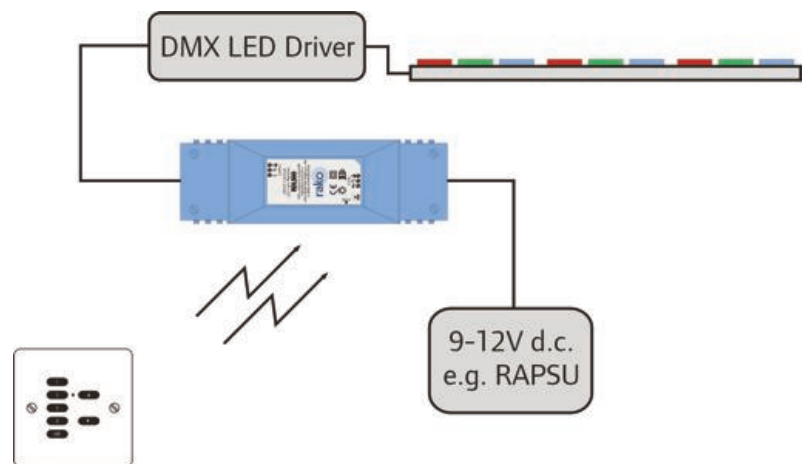

APPLICATION SHEET

# RAKO CONTROLS

MODULE TYPES (SEE DATA SHEETS FOR MORE DETAIL)

### Control Panels & Hand-held Remotes

The standard panel is the RCP07, giving 4 scenes, off plus raise/lower. Addressing switches on the back of the panel stop adjacent rooms and houses interfering with each other. Setting two panels with the same addresses allows two way control within a room. As these panels are selecting scenes stored within the dimmers having more panels does not give more scenes. Panels can either be surface mounted using the patress, which gives a depth of 14mm, or flush mounted into a standard single gang UK back-box. Panels are battery powered with battery life calculated as being 3 years, based on pressing a button 30 times a day. Externally powered versions of the panels are available. Two button panels (RCP02) give simple ON/OFF control and can be useful for Master House control applications. The Rako RAH07 remotes have all the same functionality as the RCP07 wall panels but in a hand-held casing.

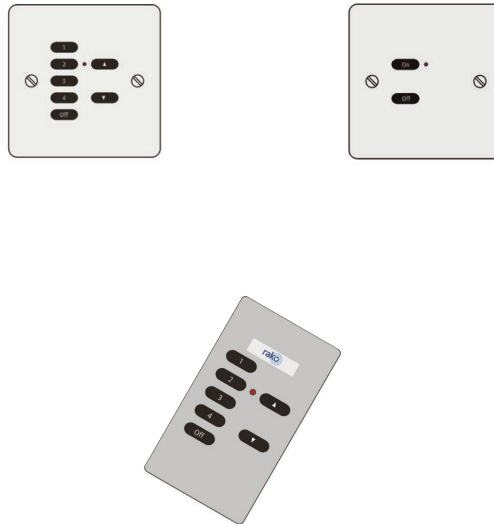

### Curtain, Blind & Projector Screen Control

Rako's RACUB unit is fitted with two isolated relays which can be used to control either mains or low voltage curtain or blind motors. Both relays should be interlocked, preventing mains ever being fed to both coils simultaneously and utilise the 'delay on changeover' feature which gives a brief pause when reversing a motor, preventing the large back EMF currents that can cause relay welding. Because blind motors can back-feed each other when connected in parallel it is normal to use one RACUB per blind. This may not be necessary with all motor types, particularly low voltage or curtain motors. RACUBs can be controlled from a lighting scene plate but this dictates that the state of the curtains/blinds is inextricably linked with the lighting scene. It is more common to have separate controls for the RACUB units allowing independent operation. The RPS range of wallpanels, the RAH03 hand-held and the RCP07/03 and RCP07/06 (combined lighting and curtain/blind control) panels are designed for operating RACUBs.



APPLICATION SHEET

# RAKO CONTROLS

ACCESSORIES (SEE DATA SHEETS FOR MORE DETAIL)

### Astronomic Timeclock

The MB1 timeclock module allows timed events to be programmed and having an astrological function events can be timed according to Dawn or Dusk. The MB1 also has a 'holiday mode' which can record two weeks worth of normal lighting control and replay this when the property is unoccupied. If Rako modules control curtains or blinds then these will also follow normal daily operation. For trained users with Rako's software package the MB1 also has the facility to control Macro and Mapping functions which can give sequenced and pathway lighting effects.



### 100M REPEATER BOOSTER

Where range may be an issue, due to particularly long transmission distances the RAB100 repeater unit can be used. The RAB100 requires a 9-12V dc power supply (e.g. RAPSU). To avoid repeaters getting locked in a loop a maximum of two RAB100 units can be used on any one project.

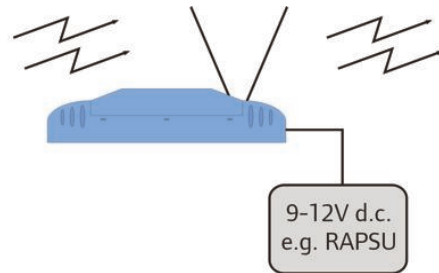
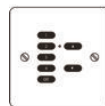

### RASOFT Programming Software

The RASOFT programming software and USB interface allows set-up addressing and programming from a PC. RASOFT allows users to store project files, gives easier programming than with the wall-panels and gives access to advanced user options.

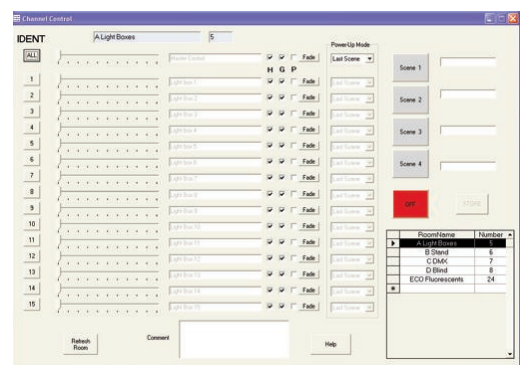
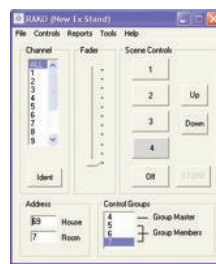

Whilst the Rako modules can all be installed as a stand alone system it is often required to have control from external sources such as all-in-one remotes, security and home automation systems

### RAVIR Interface

Infrared is line of sight so control is for the local room only. The RAVIR can be configured using RASOFT to allow control of blind and curtain control in the same room.

### Hidden RAVIR Interface

As it may not be possible to discretely mount the RAVIR module whilst still maintaining line of sight the receiver head can be remotely mounted by connecting the pins to an extension cable. This cable is not provided.

### Hidden RAVIR Interface with RF Remote

Remotes that have an RF capability give the possibility of controlling more than one physical room as the requirement for line of sight no longer exists. The RF stage of these remotes are not compatible with Rako although they can be interfaced by using the IR emitter. To control more than one room the RAVIR needs to be configured to multi-room mode using RASOFT.

### Control from Bang & Olufsen Remote

The RAVIR is available with a different infrared receiver head that allows scene control using a Bang & Olufsen infrared remote controller.

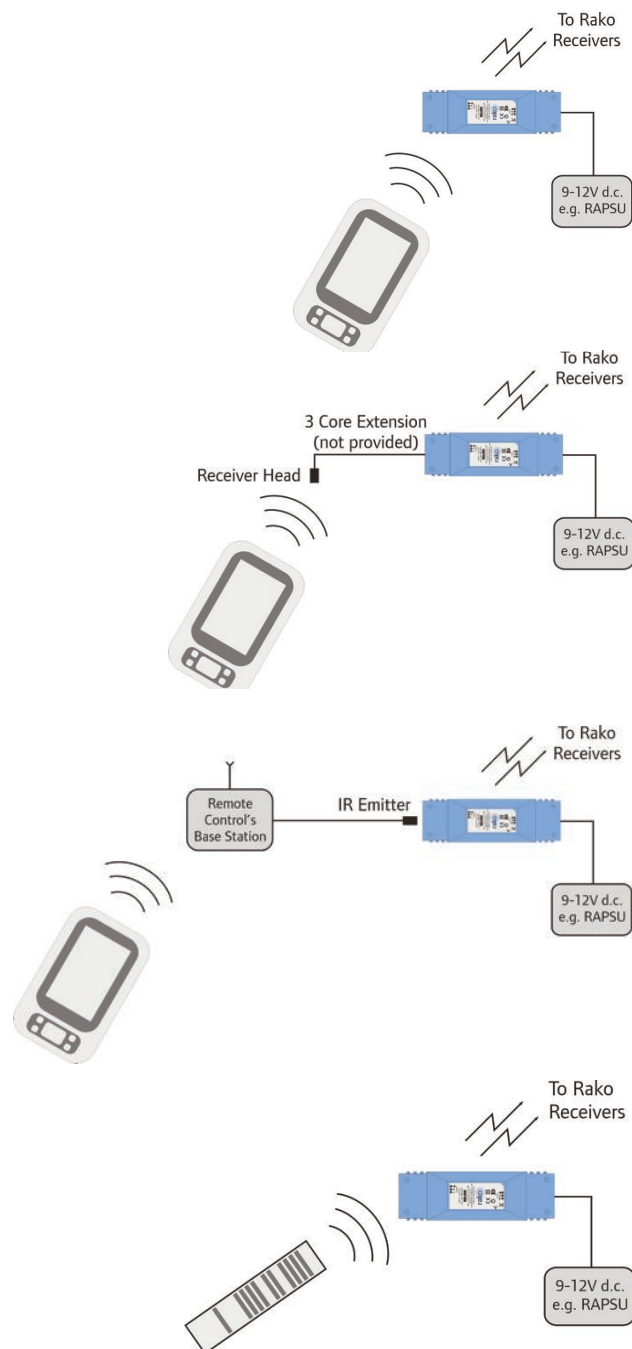

APPLICATION SHEET

RAKO CONTROLS

INTERFACING (SEE DATA SHEETS FOR MORE DETAIL)

**Interface to Security Systems**

Volt-free contact closures can be used to trigger lighting scenes using the RAVFR module. This can trigger scenes in a Room or Whole House. Reset to off can be set using RASOFT.

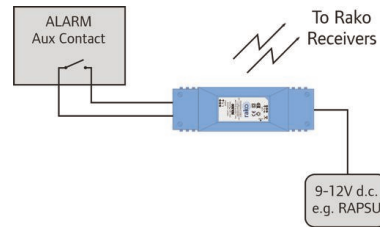

**Interfacing 3rd Party PIRs**

PIR (passive infra-red) sensors that have either a volt-free contact closure or common collector output (e.g. Setsquare Infrapod) can be used to trigger scenes. Functions such as time to off and exit delays can be set using RASOFT.

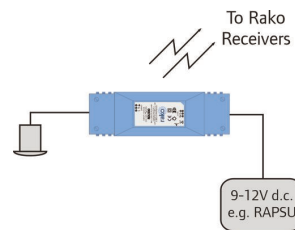

**Control from Audio-Visual systems using an RS232 serial port**

Many home control systems have RS232 ports for communicating with other systems. Rako's RAV232 plugs into the RS232 port and can receive simple ASCII command sets giving access to a wide range of instructions.

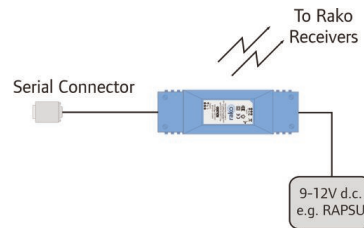

**RS232 Interfacing with Feedback**

Rako's RAV232+ has the additional facility of an RF receiver that can 'listen' to Rako transmissions in a system and give feedback to a home control system.

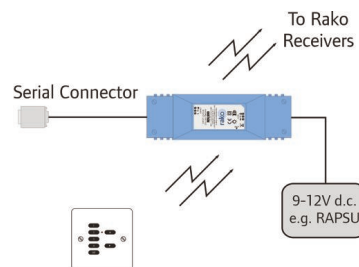

**Text Message Control**

Using a RAVSMS and GSM modem fitted with a pay-as-you-go SIM card a Rako installation can be controlled from a mobile phone by sending simple text messages.

